

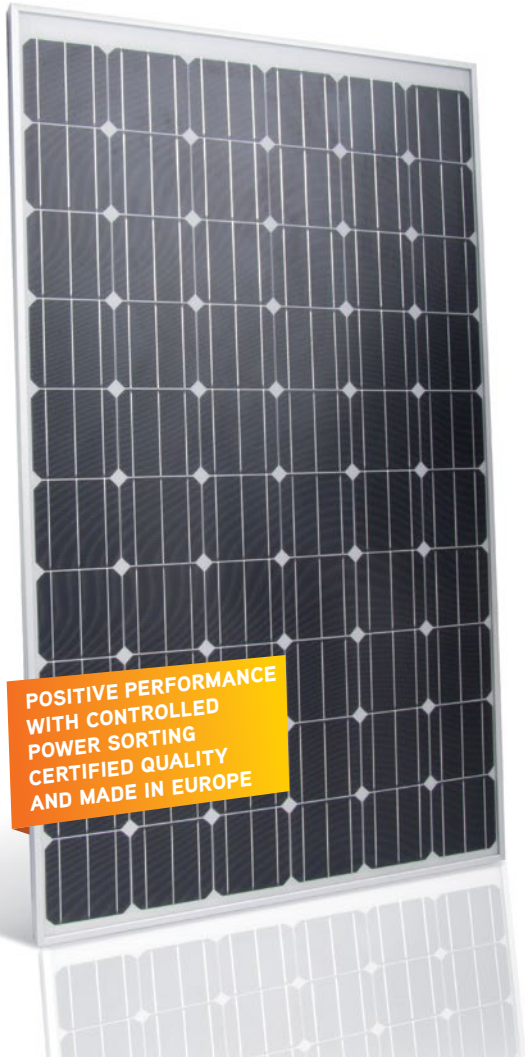

HELIENE
PHOTOVOLTAIC
MODULES

MONOCRYSTALLINE HEE215M 270 Watt

The solar module HEE215M is manufactured with high efficiency cells made by industry leading suppliers to guarantee a long lasting reliable power output. Robots allocate the 3 Bus Bar monocrystalline cells equally and interconnect the ribbon efficiently. The lightly textured glass of great optical transmission and diffused light collection covers the homogenous colored cells to create an esthetic module layout of high performance and quality design. The double reinforced anodized aluminum frame makes a rigid structure and flexible handling ideal for residential, commercial rooftop or ground mounted installations.



**POSITIVE PERFORMANCE
WITH CONTROLLED
POWER SORTING
CERTIFIED QUALITY
AND MADE IN EUROPE**



HIGH EFFICIENCY



3 BUS BAR



LIGHTLY TEXTURED GLASS



PYRAMIDAL GLASS (optional)



4 mm GLASS (optional)



12 YEAR WARRANTY



FULL BLACK (optional)



RESISTANCE TO ICE AND SNOW



LOW IRRADIATION CONDITION



60 CELLS



HARD SOLDERED JUNCTION BOX



5.400 Pa LOADING CAPACITY

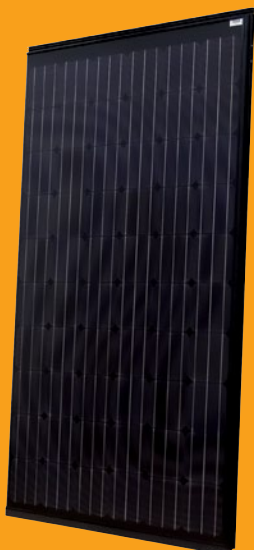

HIGH POWER OUTPUT

- 240-260 Wp. Wide range of output
- Homogeneous esthetics
- Maximum reliability

DIMENSIONS

Length x Width: 1680 x 990 mm

Thickness: 40mm

Weight: 22 kg

BIPV

Built in roof mounting systems providing maximum sealing.

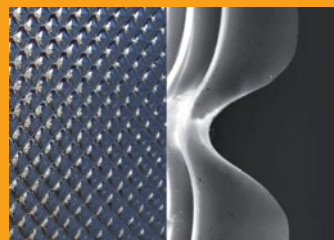

PYRAMIDAL GLASS

The pyramidal structure of solar glass ensures high production at low radiation conditions and reduces the reflection of incident light. At vertical installation the annual energy output is increased by 10%.

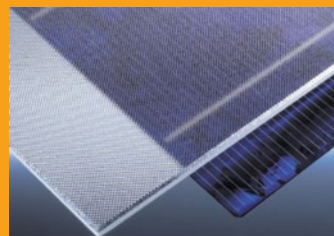

TEXTURED GLASS

We use the lightly textured glass as our standard, which provides better properties on heat dissipation and reflection loss in comparison to plain usual solar glass.

SOLAR MODULE

HEE215M

270 Watt

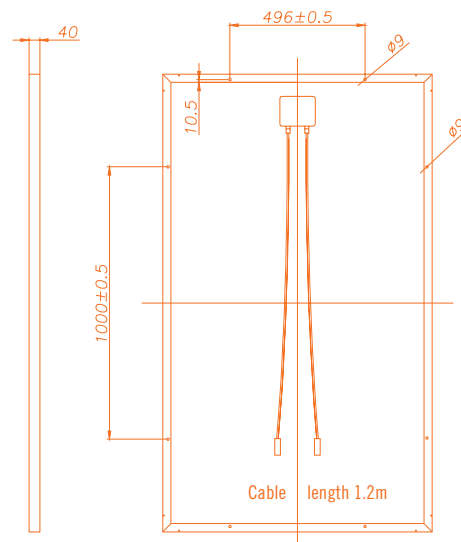
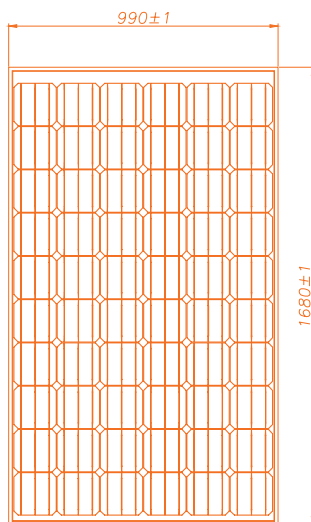
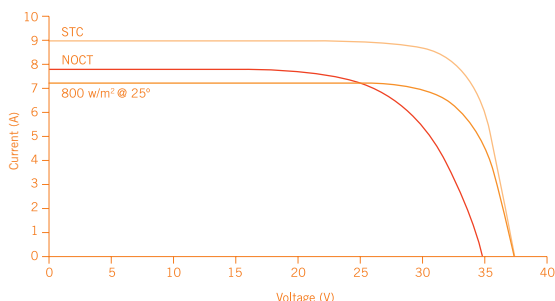

	HEE215MA72	HEE215MA71	HEE215MA70	HEE215MA69	HEE215MA68
POWER	270	265	260	255	250

STC (Standard Test Conditions)

Nominal power P_{MPP} (W)	270	265	260	255	250
Nominal voltage U_{MPP} (V)	31.25	31.05	30.84	30.65	30.3
Nominal current I_{MPP} (A)	8.64	8.55	8.46	8.32	8.22
Open circuit voltage V_{OC} (V)	38.15	37.9	37.73	37.5	37.4
Short circuit current I_{SC} (A)	9.05	8.97	8.9	8.86	8.72

STC: Irradiation 1000W/m² – Air mass AM 1.5 – Cell temperature 25°C

NOCT (Normal Operation Cell Temperature)

Nominal power P_{MPP} (W)	197	193	190	186	183
Nominal voltage U_{MPP} (V)	28.23	27.95	27.77	27.6	27.3
Nominal current I_{MPP} (A)	6.97	6.90	6.84	6.74	6.7
Open circuit voltage V_{OC} (V)	35.4	35.1	34.9	34.6	34.5
Short circuit current I_{SC} (A)	7.37	7.35	7.32	7.28	7.25

NOCT: Cell temperature (= 45°C) – Irradiation 800 W/m² – Wind speed 1m/s – Temperature 20°C

ELECTRICAL AND THERMAL CHARACTERISTICS

System tension (V): 1000	Temp. Coeff. V_{OC} (%/°C) -0.34	Temp. Coeff. P_{MPP} (%/°C) -0.43
Reverse current (A): 12	Temp. Coeff. I_{SC} (%/°C) +0.07	Operating Temp. -40 till +85 °C

MECHANICAL FEATURES

Cells	60 in series, 3BB, 6"
Glass	Lightly textured, high transparency, anti-reflective, hardened
Back sheet	Multi-layer lamination PVF and PET
Frame	Anodized aluminium in standard module / BIPV assembling
Connection	2x1.1m of cable, MC4 type connectors
Junction box	Protection index IP65, 3 diodes by-pass

MEASURING TOLERANCES Pmax: +/-3%

Warranty: 12 years on manufacturing defects and 80% nominal power at 25 years

Any additional information can be supplied under request



Friendly to Environment.

Our packaging decomposition is biological and totally degradable.

Specifications are subject to change without notice. HELIOS ENERGY EUROPE S.L. (HELIENE) 05/2014

HELIOS ENERGY EUROPE S.L.

Worldwide Headquarters
Manufacturing and Sales

Pza. del Xarol, 13-15
Pol. Ind. Les Guixeres
08915 BADALONA (Barcelona)
SPAIN

PH. +34 93 313 61 62

info@heliosenergy.es

www.heliosenergy.es

HELIENE Inc

Manufacturing and Sales

520 Allen's Side Rd
Sault Ste. Marie, ON
CANADA

www.heliene.ca

HELIOS USA

Manufacturing and Sales

1301 W Canal St.
Milwaukee, WI 53233
USA

www.helios-usa.com

BIOSOLAR

Sales and Distribution

Opstalstraat, 21
B-9620 Zottegem
BELGIUM
PH. +32 (0)9 349 36 20
FAX. +32 (0)9 349 36 21

www.heliene.nl

www.heliene.be

BAES

Sales and Distribution

Block-D, Road 31,
House-20, Shahjalal Upashahar
Sylhet-3100, Bangladesh
PH. 0821-712848

www.baes-ltd.com